



## Applications:

Auto dealerships, parking lots, walkways, roadways, campuses, facade lighting, grocery stores and other public areas.

## Features



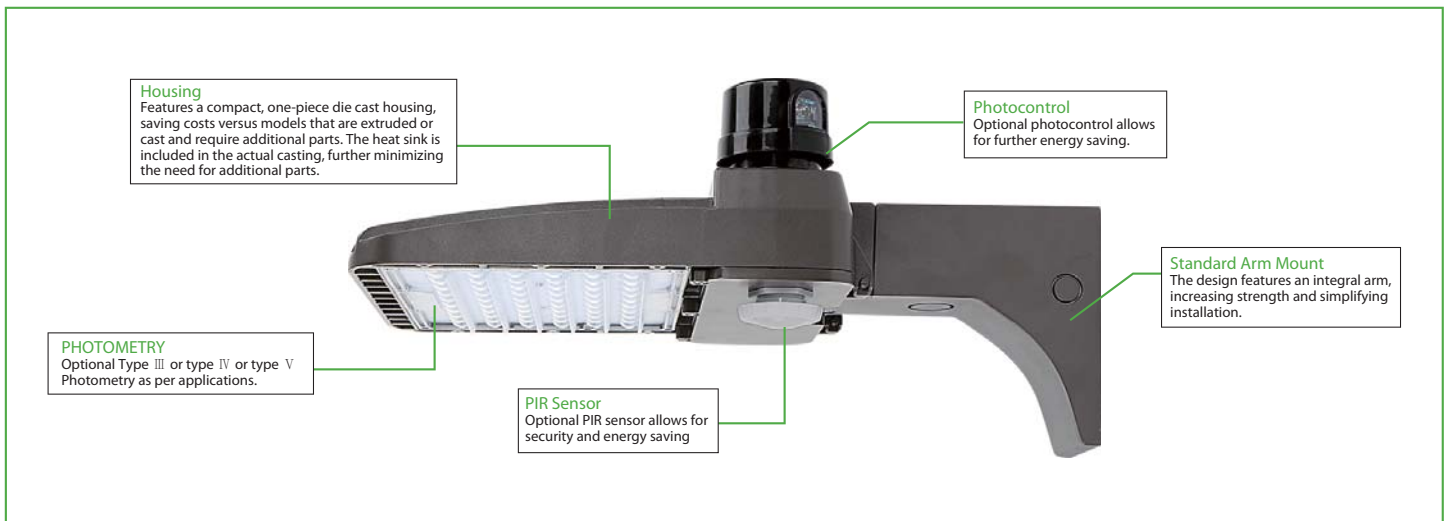



- The one piece die-cast aluminum housing with UV resistant polycarbonate optical lens, outstanding corrosion protection.
- Lumen output from 17000-19000lm with efficacy up to 127lm/W.
- Various distribution patterns including Type III and Type IV and Type V
- Suitable for mounting heights ranging from 26-40' in area lighting applications
- Round pole, Square pole, slipfitter and wall mount
- Optional for photocell. Increase energy savings with bi-level motion sensor
- Voltage is 120-277V / 347V-480V and support 0-10V dimmable
- Fixtures are IP66 rated and suitable for use in ambients from -40°C to 45 °C (-40 °F to 113 °F).
- Expected service life is over 100,000 hrs and 5 year limited warranty
- UL Wet location and DLC premium qualified



# PERFORMANCE DATA

		4000K(70CRI)					5000K(70CRI)				
SYSTEM WATTS	DIST.TYPE	LUMENS	LPW	B	U	G	LUMENS	LPW	B	U	G
150W	3	18000lm	120 lm/W	3	0	2	18500lm	123 lm/W	3	0	2
	4	17000lm	113 lm/W	3	0	3	17000lm	113 lm/W	3	0	3
	5	19000lm	127 lm/W	4	0	2	19000lm	127 lm/W	4	0	2

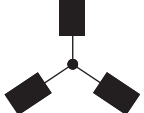
# EPA OF AREA LIGHT

Item							
	1	2 @90°	2 @120°	2@180°	3 @90°	3 @120°	4 @90°
150W	0.597	0.672	1.062	1.025	1.027	1.063	1.027

# ELECTRICAL DATA

Number Of Drivers	Driver Current (Amps)	Nominal Power (W)	INPUT VOLTAGE (V)	CURRENT (Amps)
1	3800	150	120	1.25
		150	208	0.72
		150	240	0.63
		150	277	0.54

# MOUNTING

- Standard versatile mounting arm accommodates multiple drilling patterns as well as square and round poles
- Wall Mount available for direct wall mounting and J-box mounting
- Optional for cast aluminum slipfitter mounting adapter (Compatible with more NAC mounting adaptors such as Tenon, suits for various application)

## Mounting Options



**Arm Mount** (4" and 5" Square and Round poles)  
Standard versatile mounting arm is simple to install and can be used with existing poles for retrofit installations.



**Slipfitter Mount**  
An optional cast aluminum mast arm adapter secures fixture head to nominal 2"(2-3/8" O.D. pipe size) horizontal steel tenon arm.



**Wall Mount**  
Wall Mount is easy to install for direct wall mounting with 1/2" conduit wiring or standard J-box mounting

## Mounting Dimensions

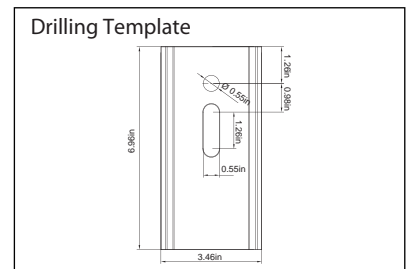
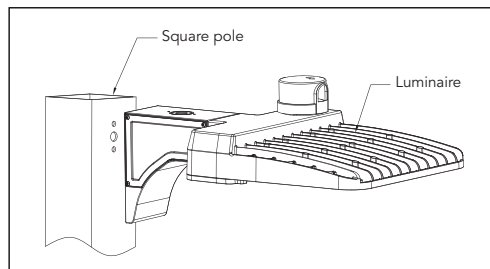
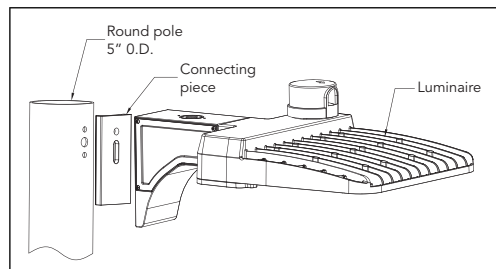

# DIMENSION

unit: inch/mm

## Slipfitter Mount

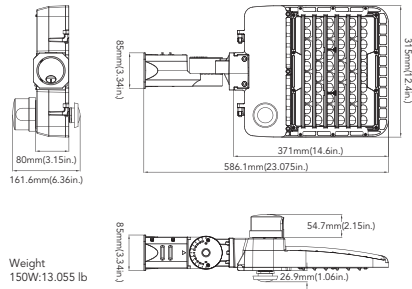

## Pole Mount

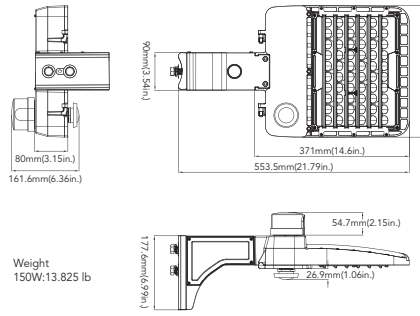

## Wall Mount

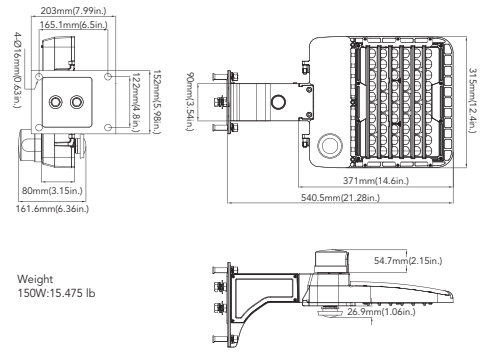

# PHOTOMETRICS

NAC offers a complete set of optical systems to meet every site lighting requirement. These systems provide remarkable flexibility in precisely matching light distribution patterns to specific site requirements.

**Type 3:**  
Type 3 optics produce an asymmetrical pattern that directs the majority of the light forward and equally on both sides of the luminaire. In a back-to-back configuration, it creates a rectangular pattern which can extend pole spacings.

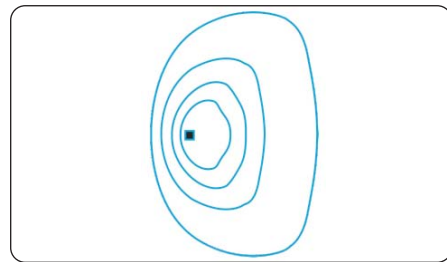

**Type 4:**  
Type 4 is suitable for applications where light is primarily required forward with minimal backlight. Typical installations include perimeter poles.

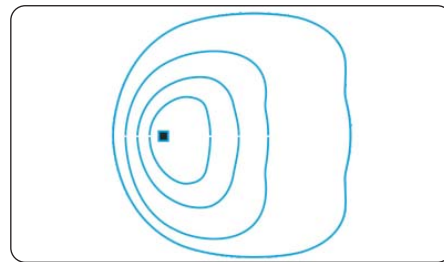

**Type 5:**  
Type 5 optics produce a symmetrical square distribution pattern that distributes light equally on all sides of the luminaire. Type 5 luminaires is universal for most area lighting applications

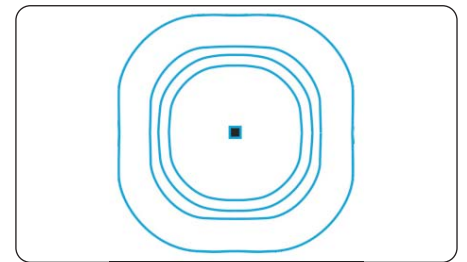

# ORDERING GUIDE



Example: MAL03 150W 27V XXK Y Y Y Y

Fixture Type	Wattage	Voltage	CCT	Finish	Photocell (Option)	Sensor (Option)	Mounting	Photometry
<input type="checkbox"/>	<input type="checkbox"/>	<input type="checkbox"/>	<input type="checkbox"/>	<input type="checkbox"/>	<input type="checkbox"/>	<input type="checkbox"/>	<input type="checkbox"/>	<input type="checkbox"/>
<b>MAL03</b> Area Light Series	<b>150</b> 150W	<b>27V</b> 120-277V	<b>40K</b> 4000K <b>50K</b> 5000K	<b>D</b> Dark Bronze <b>B</b> Black <b>W</b> White <b>SG</b> Silver Gray	<b>PO</b> 120-277V Photocell <b>Blank</b> Without Photocell	<b>M</b> With 120-277V Sensor <b>Blank</b> Without Sensor	<b>SQ</b> Square Pole Mount <b>SP</b> Slipfitter Mount <b>WM</b> Wall Mount	<b>T3</b> TYPE III Photometry <b>T4</b> TYPE IV Photometry <b>T5</b> TYPE V Photometry



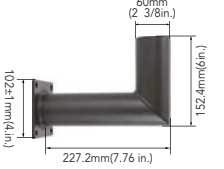

# ADDITIONAL MOUNTING ACCESSORIES

POLE BRACKET • For mounting one fixture on an existing pole			
	<p><b>4" Square Pole Mount with 2-3/8" O.D. Tenon</b> No. 45Q-SP-D Finish: Dark Bronze USE: For use with square, non-tapered steel and aluminum poles. Furnished with four 5/16" hex head stainless-steel bolts. Vertical tenon measures 2-3/8" O.D., and is made of steel tubing. Fixtures mounted to this bracket can be adjusted both vertically and horizontally.</p>		<p><b>4" Round Pole Mount with 2-3/8" O.D. Tenon</b> NO. 45QR-SP-D Finish: Dark Bronze USE: For use with Round, non-tapered steel and aluminum poles. Furnished with three 3/8" hex head stainless-steel bolts. Vertical tenon measures 2-3/8" O.D., and is made of steel tubing. Fixtures mounted to this bracket can be adjusted both vertically and horizontally.</p>
	<p><b>5" Square Pole Mount with 2-3/8" O.D. Tenon</b> No. 55Q-SP-D Finish: Dark Bronze USE: For use with square, non-tapered steel and aluminum poles. Furnished with four 5/16" hex head stainless-steel bolts. Vertical tenon measures 2-3/8" O.D., and is made of steel tubing. Fixtures mounted to this bracket can be adjusted both vertically and horizontally.</p>		<p><b>5" Round Pole Mount with 2-3/8" O.D. Tenon</b> NO. 55QR-SP-D Finish: Dark Bronze USE: For use with Round, non-tapered steel and aluminum poles. Furnished with three 3/8" hex head stainless-steel bolts. Vertical tenon measures 2-3/8" O.D., and is made of steel tubing. Fixtures mounted to this bracket can be adjusted both vertically and horizontally.</p>
	<p><b>Pole Bracket accessories-Tenon &amp; Yoke Adaptor</b> NO. SP-TR-D Finish: Dark Bronze USE: The 2-3/8" OD Tenon Mount Adaptor for Yoke Fixtures is designed to mount NAC light fixtures that are equipped with a yoke mount onto a 2-3/8" OD tenon. It may be utilized with the NAC Flood Light Series of light fixtures.</p>		

# ADDITIONAL MOUNTING ACCESSORIES

<b>WALL BRACKET</b> <ul style="list-style-type: none"> <li>Attaches to any flat surface</li> <li>Provides wiring access</li> </ul>	<b>Mid-Pole tenon Bracket</b>
 <p><b>90° Wall Mount Bracket with 2-3/8" O.D. Tenon</b>            NO. WM-SP-D            Finish: Dark Bronze            USE: The 90° wall mount bracket with 2-3/8" tenon attaches an NAC floodlight to almost any surface: wall, roof, or wood pole. Provides wiring access and abuilt-in 2-3/8" O.D. tenon to mount a fixture with our adjustable slipfitter. Suggested 3/8" diameter bolts for mounting. Mounting holes are spaced 3-1/4" apart.</p>	 <p><b>2-3/8" OD Horizontal Tenon Mid-Pole Bracket</b>            NO. SQ-SP-D            Finish: Dark Bronze            USE: 2-3/8" OD Horizontal Tenon Mid-Pole Bracket is designed to mount light fixture that is equipped with a adjustable slipfitter onto a 2-3/8" OD horizontal tenon</p>

## Round External Mount Horizontal Tenon · To mount 2/3/4 fixtures on a existing pole

 <p><b>Double 90° Horizontal Tenon Adaptor</b>            NO. R60-SP2-90-D            Finish: Dark Bronze            USE: The Bracket is designed to mount over 2-3/8" (60mm) O.D. vertical tenon. Two fixtures can be mounted to the Round External Mount Horizontal Tenon and adjusted horizontally</p>	 <p><b>Triple 120° Horizontal Tenon Adaptor</b>            NO. R60-SP3-120-D            Finish: Dark Bronze            USE: The Bracket is designed to mount over 2-3/8" (60mm) O.D. vertical tenon. Three fixtures can be mounted to the Round External Mount Horizontal Tenon and adjusted horizontally</p>
 <p><b>Double 180° Horizontal Tenon Adaptor</b>            NO. R60-SP2-180-D            Finish: Dark Bronze            USE: The Bracket is designed to mount over 2-3/8" (60mm) O.D. vertical tenon. Two fixtures can be mounted to the Round External Mount Horizontal Tenon and adjusted horizontally</p>	 <p><b>Quad 90° Horizontal Tenon Adaptor</b>            NO. R60-SP4-90-D            Finish: Dark Bronze            USE: The Bracket is designed to mount over 2-3/8" (60mm) O.D. vertical tenon. Four fixtures can be mounted to the Round External Mount Horizontal Tenon and adjusted horizontally</p>
 <p><b>Triple 90° Horizontal Tenon Adaptor</b>            NO. R60-SP3-90-D            Finish: Dark Bronze            USE: The Bracket is designed to mount over 2-3/8" (60mm) O.D. vertical tenon. Three fixtures can be mounted to the Round External Mount Horizontal Tenon and adjusted horizontally</p>	

# BACKLIGHT CONTROL ACCESSORIES

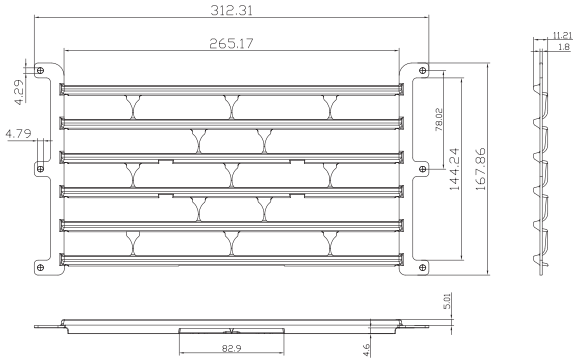
<p><b>Backlight Control</b>            NO. SC-AL01-150W-BA            USE: It will reduce the light spill behind the pole.            Finish: Black            Only suitable for 150W to 300W.</p>

# DLC Model NO.

SYSTEM WATTS	VOLTAGE	CCT	DIST. TYPE	DLC NO.	DLC Classification
150	120-277V	4000K	3	MAL03150W27V40K[D, B, W, SG][Blank, PO][Blank, M][SQ, SP, WM]T3	Premium
		5000K	3	MAL03150W27V50K[D, B, W, SG][Blank, PO][Blank, M][SQ, SP, WM]T3	Premium

